

INTERNATIONAL®  
LT® SERIES



INTERNATIONAL®  
LT® SERIES





# BAR RAISED. STANDARD SET.

## INTRODUCING THE NEW LT® SERIES

The world is changing. Technology is advancing. The powertrains of the future are all but determined. But the cargo that drives the economy of today still needs to be carried, goods still need to be delivered and businesses still need to run as efficiently as possible – now more than ever. And that is the core mission of the new International® LT® Series equipped with the revolutionary International® S13 Integrated Powertrain. A combination that brings powerful performance with mind-blowing fuel economy in a simple, easy-to-service design.







# TWO WAYS TO



No two businesses are the same. And while their vehicle needs may vary drastically, their commitment to generating revenue is universal. That's why no matter which one you choose, every LT® Series brings profit-boosting efficiency, uptime-boosting dependability, and driver-friendly usability.

---

International® S13 Integrated Powertrain

---

Included Aerodynamic and Powertrain Packages to maximize fuel efficiency

---

Standard Bendix® Wingman® Fusion™ Collision Mitigation System

---

Standard Predictive Cruise Control for greater fuel efficiency and lower operating costs

---

Sleek new grille design



# RULE THE ROAD



---

International® A26 or Cummins® X15 engine

---

Standard Bendix® Wingman® Fusion™  
Collision Mitigation System

---

Standard Predictive Cruise Control  
for greater fuel efficiency and lower  
operating costs

---

Available Eaton Endurant™ transmission  
delivers best-in-class service intervals,  
smooth shifting, and lightweight design

---



**WE WENT TO GREAT  
LENGTHS TO FIND  
EFFICIENCIES**

**THEN WE  
TOOK IT  
FURTHER**

Achieving the lofty efficiency goals meant our engineers needed to search for improvements in a variety of areas from the powertrain to aerodynamics. The combination of the cab airflow upgrades with the new International® S13 Integrated Powertrain can achieve up to a 15% gain in fuel economy\* over the popular first-generation International® A26. This is one reason why the new LT® Series equipped with the S13 Integrated Powertrain is expected to set a new standard for the industry.

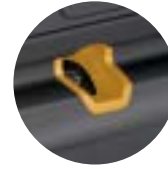

**AERO PACKAGE WITH  
CHASSIS ENABLERS\*\***

By spending extensive time in the wind tunnel and through computer simulations, International® engineers were able to significantly improve the airflow of the LT Series equipped with the S13 Integrated Powertrain.



# IT ALL ADDS UP



- ▶ Pedestal mirrors reduce drag and wind noise.
- ▶ The hood top and shoulder are redesigned to enhance airflow.
- ▶ The longer 125" BBC hood better directs and smooths out airflow around the cab.
- ▶ Aerodynamic fender shape optimizes airflow.
- ▶ 25" cab extenders close the gap between cab and trailer to limit air turbulence.
- ▶ An aero-enhanced 3-piece bumper and front wheel openings are contoured to minimize resistance.
- ▶ Chassis skirts and cab closeouts have been enhanced to reduce aerodynamic drag.
- ▶ The cooling module is sealed to smooth airflow under the hood.
- ▶ The front air dam design reduces drag by efficiently pushing air down, under, and around the truck.

\* Comparing the fuel economy of the 2017 GHG International® A26 engine in a 2017 International® LT® Series truck with aero package to the fuel economy of the new International® S13 Integrated Powertrain in a 2024 International® LT® Series truck with the LT aero package and chassis enablers. Actual customer results may vary due to various factors, including but not limited to, truck specifications, weight of the vehicle, predictive features, environmental conditions, etc.

\*\* Aero package components are highlighted in yellow for illustration purposes only.



# AT THE HEART OF IT ALL

Collaboration is a beautiful thing. By combining the best thinking with years of experience in a wide range of disciplines, you can reduce potential pitfalls and accelerate progress in uncharted territory. And just like the team who developed it, the International® S13 Integrated Powertrain brings together three distinct entities — the S13 engine, the T14 transmission and the Dual Stage Aftertreatment Module — to create a whole.

## HIGH-PRESSURE FUEL SYSTEM

- 1800 bar

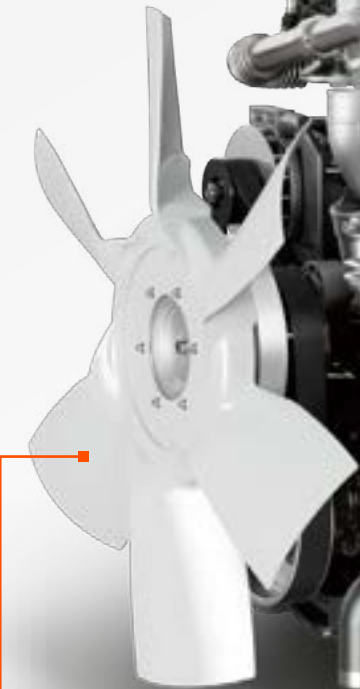

## 6-BLADE FAN

- Converted from a 10-blade to a 6-blade for additional efficiency improvement

## OIL FILTER WATER PUMP

- Low displacement, low parasitic losses

## FUEL FILTER

## OIL PAN

- Aluminum pan provides corrosion protection

## T14 TRANSMISSION

- 14-speed single countershaft geartrain transmission with wide ratio spread for efficiencies on flatlands and performance on hilly terrains

## AIR COMPRESSORS

- Single cylinder (iron)
- Two cylinder (aluminum)
- Two cylinder clutched (aluminum)

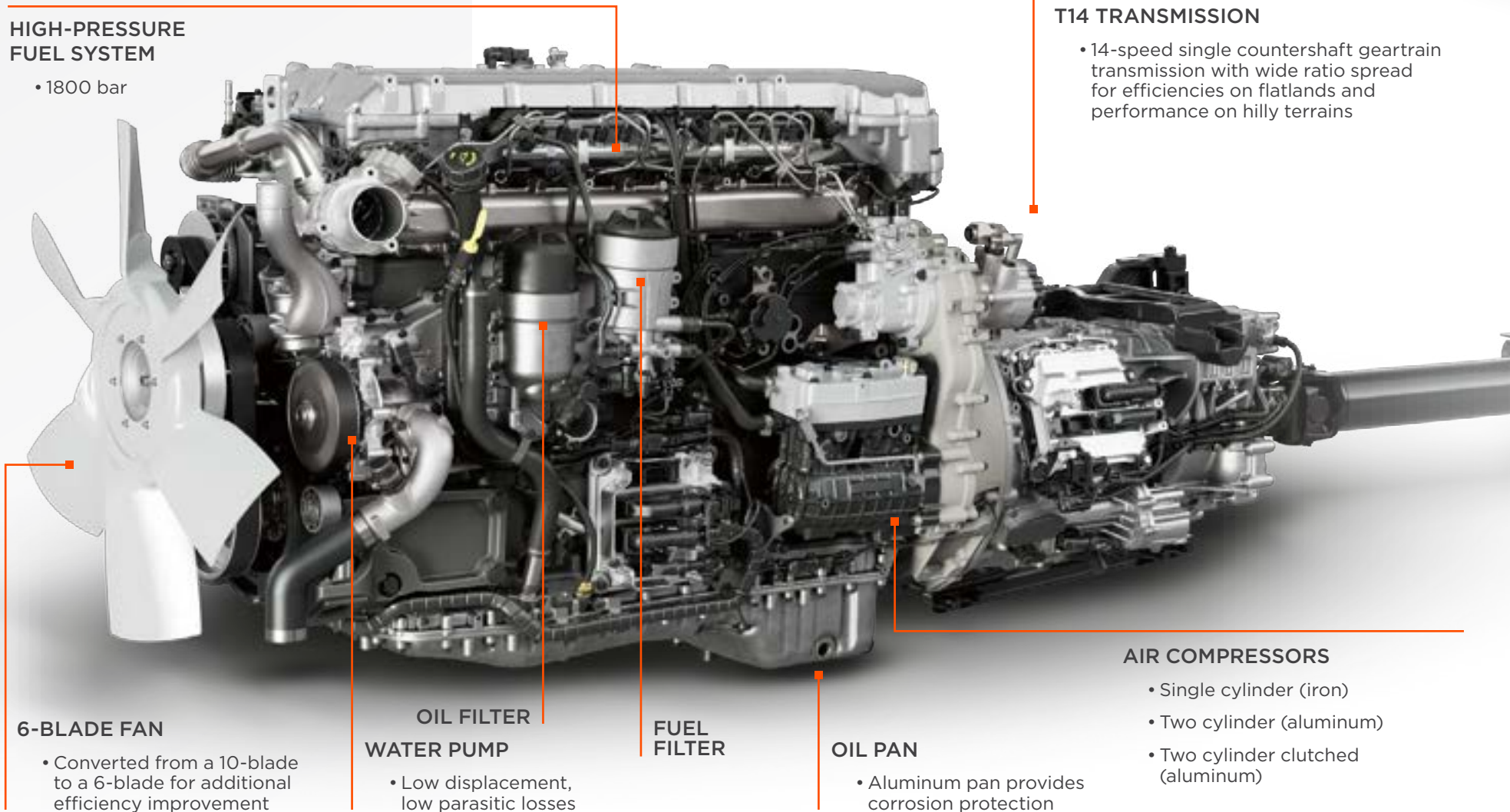



### DUAL STAGE AFTERTREATMENT

- Compact design for more frame rail mounting space
- No active DPF regen needed

### NO COOLED EGR

- EGR cooler not required with this advanced engine design

### ALUMINUM VALVE COVER

### FIXED GEOMETRY TURBO

- More reliable and efficient design



**Up to 15%  
More Fuel Efficient\***



## Connected Technology

OnCommand® Connection transforms performance data into critical insights that help drive greater uptime and reduce total cost of ownership

\* Comparing the fuel economy of the 2017 GHG International® A26 engine in a 2017 International® LT® Series truck with aero package to the fuel economy of the new International® S13 Integrated Powertrain in a 2024 International® LT® Series truck with the LT aero package and chassis enablers. Actual customer results may vary due to various factors, including but not limited to, truck specifications, weight of the vehicle, predictive features, environmental conditions, etc.



# SHIFT WHAT'S POSSIBLE

Any engine, no matter how well designed, is only as good as the transmission it's mated to. Delivering the power to the road in a smooth, predictable manner is no small feat when you consider the amount of torque of heavy-duty trucks. By starting with a clean sheet of paper, our engineers behind the S13 Integrated Powertrain were able to make sure the engine and transmission work in perfect harmony. The result is the fully automated T14 manual transmission with 14-speed overdrive. Its shifts are seamless and require no input from the driver in terms of being in the right gear at the right time.

## SHIFT ACTUATORS

- Shift actuator packaging was designed specifically for automated functionality (rather than adapted from a manual), allowing for more compact gearbox housing

## VARIABLE OIL LEVEL UPPER RESERVOIR

- Oil is pumped to the reservoir under lower loads to reduce parasitic losses, allowing for the continuous lubrication of gears by the oil sprayers

## PLANETARY GEARS

- The planetary gear set eliminates the need for a dedicated reverse gear, shortening the gearbox and allowing for better packaging within the chassis

## SINGLE COUNTERSHAFT

- A single countershaft with helical gears lowers the overall weight of the unit without compromising the durability or performance of the transmission

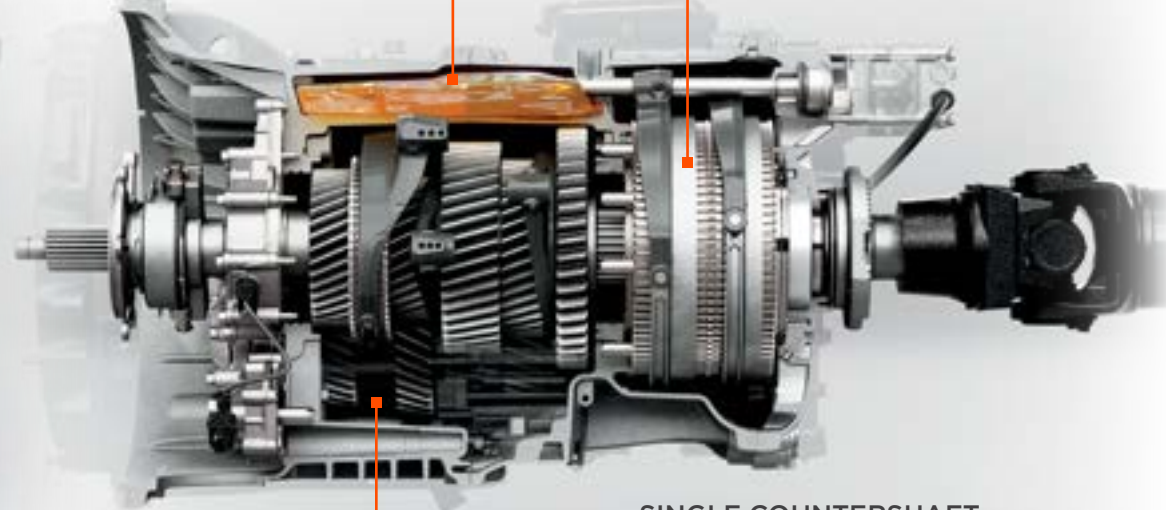

## THE TRANSMISSION CONTROL MODULE (TCM)

Features like predictive cruise control, neutral coast, downhill speed control, and predictive shifting, can now be found in one module — the TCM. Combining these features into one module means the vehicle feels more natural and intuitive and, ultimately, more efficient.

The transmission has an electronically controlled clutch actuator that works in sync with the engine to deliver faster, smoother shift performance. Since it does not consume air during complicated maneuvers, like when you're backing a trailer into a tight loading dock, the driver never needs to stop and let the air recharge.



## DRIVER SHIFT MODES

Three different shift modes (optional) for ultimate control for the driver

- ▶ Economy — Predictive shifting with fuel efficiency focus
- ▶ Performance — Perfect balance
- ▶ Performance+ — Shifting at peak power with focus on performance



## DOWNHILL SPEED CONTROL

Cruise control using the engine brake to slow down to a specific speed. Control at the wheel to manage speed going downhill.

## ECO-COAST

Disengages the driveline when traveling downhill, using the momentum of the vehicle to save fuel.

## MANEUVERING MODE

Gives the driver more control of the vehicle at low speeds for specific movements, such as reversing into a loading dock, connecting to a trailer, or other low-speed maneuvers. Torque value for pedal input is reduced. This mode allows the clutch to slip more easily for slow and smooth performance.

## CREEP MODE

Allows the vehicle to automatically start moving when the brake pedal is released while the transmission is in gear. Useful in high traffic and other events where constant vehicle movement is necessary without the use of the accelerator pedal.



# LEGACY PERFORMERS



## INTERN

The 2021 International® A26 engine offers premium performance in an advanced, fuel-efficient 12.4L design. The A26 produces up to 515 hp and 1,850 lb.-ft. of torque from a design with a best-in-class dry weight of 2,314 lbs. and is 600 to 700 lbs. lighter than traditional big bore engines. It also features North America's first Class 7-8 Compacted Graphite Iron (CGI) crankcase design.

# INTERNATIONAL® A26

**Lightweight, Quiet,  
and Efficient Power**



**Variable Geometry Turbocharger** — Titanium compressor wheel provides excellent longevity. Serviceable electronic actuator increases uptime and reduces service cost.

**Jacobs Engine Brake** — Variable Geometry Turbocharger improves engine braking performance, particularly at low-to-mid-RPMs and higher altitudes.

**2500 Bar High-Pressure Common Rail Fuel System** — Delivers maximum fuel injection pressure (36,300 psi) to reduce emissions and fuel consumption, with multiple injection events for smooth and quiet operation.

**Lightweight design** — Compacted Graphite Iron crankcase, shot-peened aluminum flywheel housing, composite valve covers, and a hollow camshaft deliver a lightweight design, maximizing payload capacity.

**Cold starting** — Cold starting down to -40°F with available oil heater, coolant heater, and cold start system with unaided cold starting down to 10°F for dependable starting in extreme climates or when plug-in heating isn't available.

# CUMMINS® X15

**Proven Muscle  
for the Long Haul**

Legendary Cummins power in the X15 Productivity, Performance, and Efficiency Series configurations. The X15 Efficiency Series produces up to 500 hp with advanced fuel-saving technology that includes dynamic electronic controls with ADEPT features, enhanced engine breathing and an optimized combustion process that leverages Cummins' proprietary VGT™ Turbo and XPI fuel system.

**VGT Turbocharger** — Featuring a patented sliding nozzle ring, the VGT Turbocharger used on Cummins X15 engines offers higher boost pressures at low engine speeds.

**XPI Fuel System** — High pressure enables multiple injection events per cycle for industry-leading fuel economy and quieter operation. With a standard thermal recirculation valve, the X15 is prepared to handle even the most challenging weather conditions.

**Single-Module™ Aftertreatment System** — Compact and lightweight, the Single-Module Aftertreatment provides better heat management and retention, delivering improved fuel economy compared to previous aftertreatment systems.





**DRIVERFIRST™**

# LISTENING AND DELIVERING

From the very beginning, priority #1 for the LT® Series was to design a truck that drivers would really want to drive. To achieve this goal, we turned to the people who know driving best — real truck drivers.

These professionals gave us honest, priceless input during numerous research sessions and driver clinics. Then we set about redesigning, fine-tuning, and retesting until drivers agreed, “This is the truck I’ve always wanted to drive.”

That’s how the LT Series became the most driver-centric truck on the road today. It has more intuitive controls, enhanced visibility, a quieter cab, critical information at your fingertips, and dozens of other smart features that help keep a driver comfortable and in control over the long haul.







# INTEL THAT'S RELEVANT, INTUITIVE, AND CUSTOMIZABLE

Every detail inside the LT® Series cab has been carefully designed, measured, and clinic-tested to optimally benefit the driver. The gauges received numerous tests and refinements to optimize their readability, usability and positioning, so key information and alerts are precisely where they need to be to view without distraction. The standard premium gauge cluster features a customizable digital display that lets drivers intuitively select the information they prefer in a variety of situations.

The color, illumination, legibility — and even the type font and size of gauges — is designed to deliver optimal viewing in varying light conditions, maximizing alertness and minimizing eye fatigue.



Driver safety is always a top priority. The Fusion™ system with Lane Departure Warning (pictured) is available on a number of International Wingman Advanced models.





The premium gauge cluster includes a customizable digital display that provides a wealth of information for the driver, including:

- Real-time fuel economy
- Axle load\*
- Custom gauge settings\*
- Safety indicators\*
- Digital speedometer
- Tire pressure\*

ays a priority. That's why the LT Series includes standard Bendix® Wingman® (with collision mitigation technology, adaptive cruise control, lane departure (here), over-speed alert, and stationary vehicle braking. You can also select proven stand-alone safety systems to meet your specific needs. Bendix® and Wabco OnGuard ACTIVE™ are also available.

\*When added with optional feature code for required sensors



# TAILOR THE LT<sup>®</sup> SERIES TO SUIT YOUR DRIVER...

## Cab Features

Cab Trim Panels
Door Trim
Trim Inserts
Instrument Panel
Gauge Cluster
Accent Color
Sun Visors
Lighting
Window Controls
Lock Controls
Cup/Bottle Holders
Overhead Console
USB Accessory Port

## Classic

Easy-to-Clean, Soft Touch Vinyl
Easy-to-Clean, Soft Touch Vinyl
Neutral
Black
8-Gauge, 3.5" Display with Odometer and Trip Optional: Premium 8-Gauge, 5" Color Display with Virtual Gauges
Neutral
Two
LED
Power
Manual or Power
Four
Molded Plastic with Retainer Nets and CB Radio Housing and Paper Towel Storage in Sleeper Configuration
Up to 4

# AND FIT YOUR BUSINESS



Diamond

## Diamond

- Mineral Grey Teak
- Easy-To-Clean, Soft Touch Vinyl with Mineral Grey Teak Inserts with Chrome Handle
- Mineral Grey Teak Trim
- Black
- 8-Gauge, 3.5" Display with Odometer and Trip  
Optional: Premium 8-Gauge, 5" Color Display with Virtual Gauges
- Mineral Grey Teak
- Two
- LED
- Power
- Power
- Four
- Molded Plastic with Retainer Nets and CB Radio Housing and Paper Towel Storage in Sleeper Configuration
- Up to 4



Diamond Elite

## Diamond Elite

- Satin Mahogany
- Easy-To-Clean, Soft Touch Vinyl with Satin Mahogany Inserts with Chrome Handle
- Satin Mahogany Trim
- Black
- 8-Gauge, 3.5" Display with Odometer and Trip  
Optional: Premium 8-Gauge, 5" Color Display with Virtual Gauges
- Satin Mahogany
- Two
- LED
- Power
- Power
- Four
- Molded Plastic with Retainer Nets and CB Radio Housing and Paper Towel Storage in Sleeper Configuration
- Up to 4



73" Hi-Rise Sleeper shown in Diamond Elite trim

Not all trips require the same amount of bunk space. In fact, some trucks may be operated by one driver on the way out and two drivers on the way back. With the new, flip-up bunk, those who would rather have the extra headroom can simply raise the extra bunk and enjoy the wide open space.



<b>Sleeper Features</b>	<b>Classic</b>	<b>Diamond</b>	<b>Diamond Elite</b>
<b>12-Volt Power Supply</b>	Standard	Standard	Standard
<b>Trim Panels</b>	Easy-to-Clean, Soft Vinyl Neutral Trim Panels	Easy-to-Clean, Soft Touch Vinyl with Mineral Grey Teak Accents	Easy-to-Clean, Soft Touch Vinyl with Satin Mahogany Accents
<b>Headliner</b>	Soft Vinyl	Soft Vinyl	Soft Vinyl
<b>Sleeper Windows</b>	Standard	Standard	Standard
<b>Windshield Curtain</b>	Optional	Optional	Optional
<b>Sleeper Control Panel</b>	Standard	Standard	Standard
<b>Microwave Accommodation</b>	Optional	Optional	Optional
<b>TV Accommodation</b>	Optional	Optional	Optional

### 56" Low-Roof Sleeper Features

<b>Overhead Storage</b>	Two Airline-Style Cabinets Standard, with an Option for Two Additional	Two Airline-Style Cabinets Standard, with an Option for Two Additional	Two Airline-Style Cabinets Standard, with an Option for Two Additional
-------------------------	--	--	--

### 56" Hi-Rise Sleeper Features

<b>Overhead Storage</b>	Two or Four Compartments with Netting	Two Compartments with Netting or Doors	Two Compartments with Netting or Doors
<b>Rear Wall Storage</b>	Optional	Optional	Optional

### 73" Hi-Rise Sleeper Features

<b>Overhead Storage</b>	Optional Two or Four Compartments with Nets or Optional Doors	Optional Two or Four Compartments with Nets or Optional Doors	Optional Two or Four Compartments with Nets or Optional Doors
<b>Rear Wall Storage</b>	Optional	Standard	Standard
<b>Driver Side Wardrobe</b>	Standard, Optional Doors	Standard, Optional Doors	Standard, Optional Doors
<b>Passenger Side Cabinets</b>	Utility Cabinet, Lower Right Wardrobe Tower Cabinet, Dresser Cabinet, Refrigerator, Storage with or without Doors	Utility Cabinet, Lower Right Wardrobe Tower Cabinet, Dresser Cabinet, Refrigerator, Storage with or without Doors	Utility Cabinet, Lower Right Wardrobe Tower Cabinet, Dresser Cabinet, Refrigerator, Storage with or without Doors

### 73" Sky-Rise Sleeper Features

<b>Overhead Storage</b>	Two Compartments with Nets	Two Compartments with Nets	Two Compartments with Nets
<b>Rear Wall and Upper/Lower Storage</b>	Standard	Standard	Standard
<b>Driver Side Cabinets</b>	Standard Lower and Upper Storage with Shelves, Nets or Optional Doors	Standard Lower and Upper Storage with Shelves, Nets or Optional Doors	Standard Lower and Upper Storage with Shelves, Nets or Optional Doors
<b>Passenger Side Wardrobe</b>	Standard Cabinet Tower Wardrobe and Optional Door, Shelves and Net	Standard Cabinet Tower Wardrobe and Optional Door, Shelves and Net	Standard Cabinet Tower Wardrobe and Optional Door, Shelves and Net



# DESIGNED WITH FLEETS IN MIND

FITS INTO YOUR FLEET  
LIKE YOUR FAVORITE  
PAIR OF WORK GLOVES

The new International® LT® Series was engineered to seamlessly integrate into fleets of all sizes. Not only can fleets benefit from exceptional fuel economy, but they also get extended service intervals to keep their equipment on the road, plus the largest service network in the industry for convenient access to white-glove treatment from ASE-Certified technicians. All LT Series powertrains are designed to work seamlessly with OnCommand® Connection Advanced Remote Diagnostics, which has helped some fleets reduce vehicle failures requiring a tow by up to 80%.

#### FLEET FRIENDLY

- ▶ **Largest North American service network in the industry (with Love's network)**
- ▶ Single point of service for vehicle and powertrain
- ▶ Extended service/maintenance intervals
- ▶ Wide selection of warranty and extended service Contracts





# A VISION FOR SAFETY

It's estimated that 20%-30% of truck accidents are related to field of vision. That's why the LT® Series provides impressive forward and lateral visibility. Cab doors have been redesigned with a lower bottom glass edge and no vent window seam for enhanced visibility and reduced blind spots.

## ROOM TO APPRECIATE

The door panels help increase hip and elbow room while providing a more comfortable place to rest your arm. The full-grip interior handle makes doors easier to open and close, while the door pockets offer easier access to maps or paperwork.

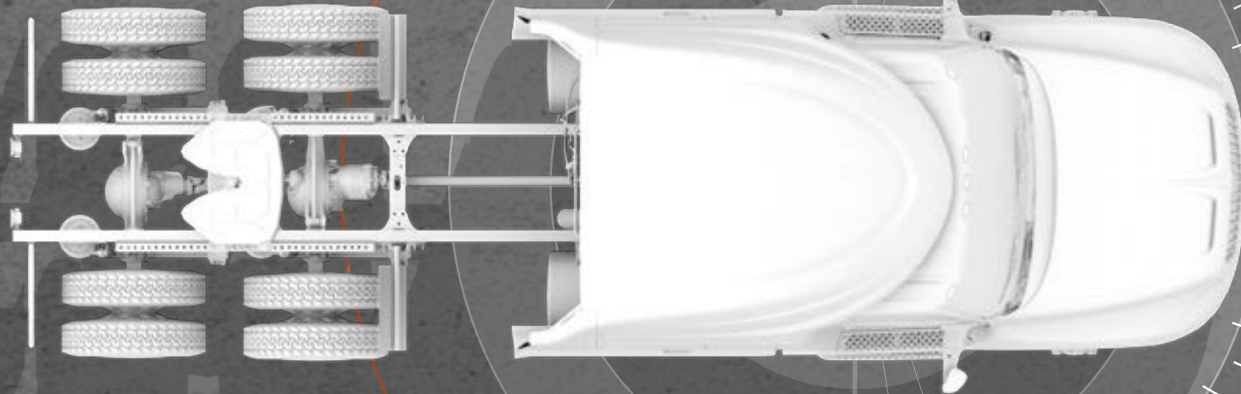

## EASIER SLEEPER ACCESS

Improved driver pivot access, seat recline, greater leg room, and a redesigned lower console make it easier to turn in for the night.



## SEE THAT IT'S DONE

By reshaping the doors and side glass, the position of the cab mirrors was optimized so drivers turn their heads less, making it easier to keep their eyes on the road while reducing neck strain over the long haul.



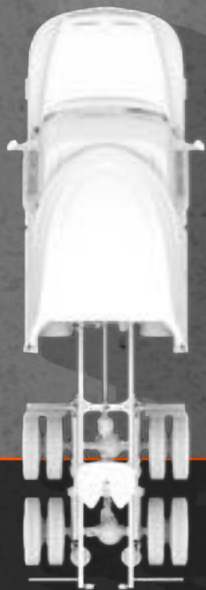
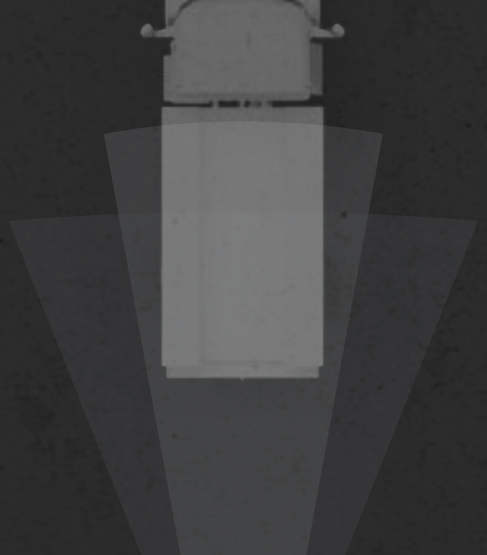

### BENDIX® WINGMAN® SYSTEMS

The optional Bendix® Wingman® Advanced™ and Bendix Wingman collision mitigation systems can greatly enhance operator safety. By integrating adaptive cruise control, lane departure warning, over-speed alert and stationary vehicle braking, these cutting-edge systems can help the driver potentially avoid a collision or help reduce its severity.

Wabco OnGuard ACTIVE is also available.

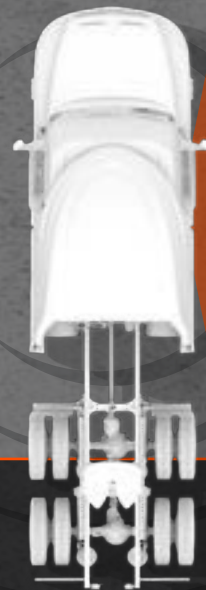

### BENDIX® BLINDSPOTTER®

When connected to the vehicle's Control Area Network (CAN), the optional Bendix BlindSpotter® provides a 150° range of coverage capable of detecting objects up to 20 feet in front of and 20 feet behind the BlindSpotter radar. The coverage zone extends up to 10 feet to the right of the vehicle. BlindSpotter minimizes false alerts by operating in two modes: highway speeds and lower speeds.

HIGH-SPEED ZONE

UP TO 150°

SLOW-SPEED ZONE

HIGH-SPEED ZONE



### LED HEADLIGHTS

LED headlights offer unparalleled nighttime visibility for improved safety, whether you're inside the cab or out.



# CRITICAL VEHICLE HEALTH DATA AT YOUR FINGERTIPS

OnCommand® Connection Advanced Remote Diagnostics transforms raw vehicle data into actionable insights to help you stay in front of potential vehicle issues and keep your LT® Series at peak performance.



## FEATURES INCLUDE:

- Reports on vehicle health issues that include severity ratings, likely needed parts and service, and recommended actions
- Comprehensive vehicle health reports that include performance data, fault history, and more
- Up-to-date GPS location with customizable geofencing reports that can help ensure vehicles are where they need to be
- Insights delivered how you need it — via our online portal, your email inbox, a mobile app, and more.

OCC Go Screen

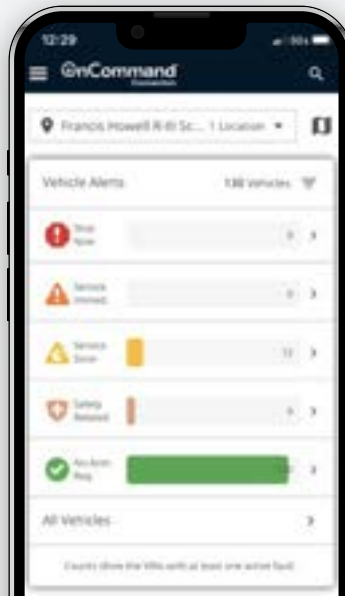

## TAKE YOUR PERFORMANCE TO THE NEXT LEVEL

We offer additional tools powered by OnCommand® Connection designed to give your business and operations that extra edge.

<b>OTA Programming</b>	Ensure peak performance with remote software calibration updates to the S13 Integrated Powertrain, anytime, anywhere
<b>Fleet Health Monitoring</b>	Reduce breakdowns with weekly reports on vehicles at highest risk of roadside failure
<b>Advanced Preventive Maintenance</b>	Optimize PM spending with data-driven, customized interval recommendations for your trucks
<b>Advanced Fuel Analytics</b>	Improve fleet efficiency with reports on key driver behaviors and other factors that affect fuel economy (i.e., cruise control use, idle time, harsh acceleration)

# TRANSPARENT SERVICE COMMUNICATIONS WITH YOUR DEALER

Knowing when your vehicle's service and repair events will be complete is critical to keeping your business up and running. International® 360 makes the entire process faster and easier to manage.

- Updates via text and email keep you informed on the status of vehicles in service, including estimated time of completion
- Integrates telematics, dealer parts inventory, and other vital information into one easy-to-use tool
- Centralizes vehicle health data, service history, and more



New International LT® Series models come standard equipped with telematics and five years of service, including:

- **OnCommand® Connection Advanced Remote Diagnostics**
- **International® 360**
- **Intelligent Fleet Care**
  - Fleet Health Monitoring
  - Advanced Preventive Maintenance
  - Advanced Fuel Analytics
  - TPMS Integration (requires TPMS system installed on truck)
  - Gateway Integrations



**WHEN COMBINED, THESE SOLUTIONS CAN HELP FLEETS SAVE UP TO \$7,000 OR MORE OVER FIVE YEARS\***

\*depending on annual miles driven and other operational conditions



# SIMPLIFYING MAINTENANCE TO MAXIMIZE UPTIME

KEEPING YOU  
ON THE ROAD TO  
PROFITABILITY



**The faster your truck can be serviced, the faster you're back on the road, meeting delivery schedules and boosting your profitability.**

The LT® Series is designed and engineered to optimize uptime with industry-leading serviceability. All key service points under the hood, inside the cab, and around the vehicle are ergonomically designed for easy access and servicing. Many components are engineered with longer intervals between required maintenance. And when you do need service, you can count on expert technicians and an extensive parts inventory from your International® dealer.



- ▶ The LT Series hood opens wide and features gas strut control and torsion bar lift assist. The torsion bar reduces opening effort and enables the hood to be lifted with one hand. The gas strut helps dampen closing to prevent the hood from closing too quickly.
- ▶ Translucent containers allow you to check fluid levels at a glance.
- ▶ Tethered caps on most fluid containers prevent dropped or lost caps while refreshing fluids.

- ▶ Standard LED headlamps and fog lamps deliver brighter light pattern and intensity. Tough polycarbonate lenses protect against breakage.
- ▶ Driver controls and instrumentation are based on robust industry-standard SAE J1939 electrical architecture, with gauge cluster and switches designed to keep drivers focused and maximize uptime.
- ▶ Key interior fasteners are exposed for more intuitive access and easier servicing.
- ▶ The max defrost feature in the HVAC system helps clear windows faster in colder climates, providing quicker, clearer visibility for increased uptime and less waiting.
- ▶ Cab wiring features a power distribution module that's located inside the cab, protected from the elements.
- ▶ The single canister aftertreatment system is up to 60% smaller and 40% lighter than the system it replaces, with better heat management to help improve fuel economy and greater ash retention to stretch out time between service intervals. The system is also simplified for quicker servicing.

- ▶ Standard Intelligent Fleet Care provides an intuitive preventive maintenance solution with fleet health monitoring, advanced fuel analytics, and TPMS integration.
- ▶ All brake life servicing intervals are now aligned, reducing maintenance events and expense.
- ▶ New ChemGuard coating under the cab floor provides further corrosion protection.
- ▶ Models equipped with the International® A26 include over-the-air cellular programming for approved engine calibration and programmable parameters (Cummins® X15 includes engine calibration updates).
- ▶ A new chassis maintenance schedule means extended intervals, saving over 50 hours of labor time in the first 400,000 miles of operation.

#### DUAL-STAGE AFTERTREATMENT

- Compact design for more frame rail mounting space
- No active DPF regen needed

#### NO COOLED EGR

- EGR cooler not required with this advanced engine design





# DRIVING PROFITABILITY

## MORE TIME ON THE ROAD AND LESS TIME WAITING FOR REPAIRS

We understand making money means keeping your vehicles on the road. That's why uptime is so important to us. Dependable equipment spec'd for your needs or requirements is just the beginning. We also focus on fuel economy, preventive maintenance, optimized service intervals, and more to make sure the low cost of ownership of our vehicles helps keep you in the black.



Maximum Uptime - Repair before Failure



Prognostics that move unplanned repairs to planned. Optimizing maintenance using vehicle performance and predictive data.

Predictive Parts Stocking



Dealer parts inventory management uses AI and telematics data to predict stocking needs. This ensures the best parts are on dealer shelves to support customers.

# NAVISTAR FINANCIAL. UNLOCK YOUR POTENTIAL.

Navistar Financial offers flexible solutions to fit your financing needs, helping you secure the best products for your specific situation. Whether you're a loan customer or a lease customer the Navistar Financial team can provide you with the best option suited to your business.

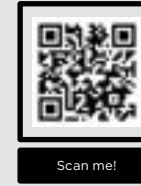

For more information or to contact Navistar Financial, scan the QR code.

Scan me!

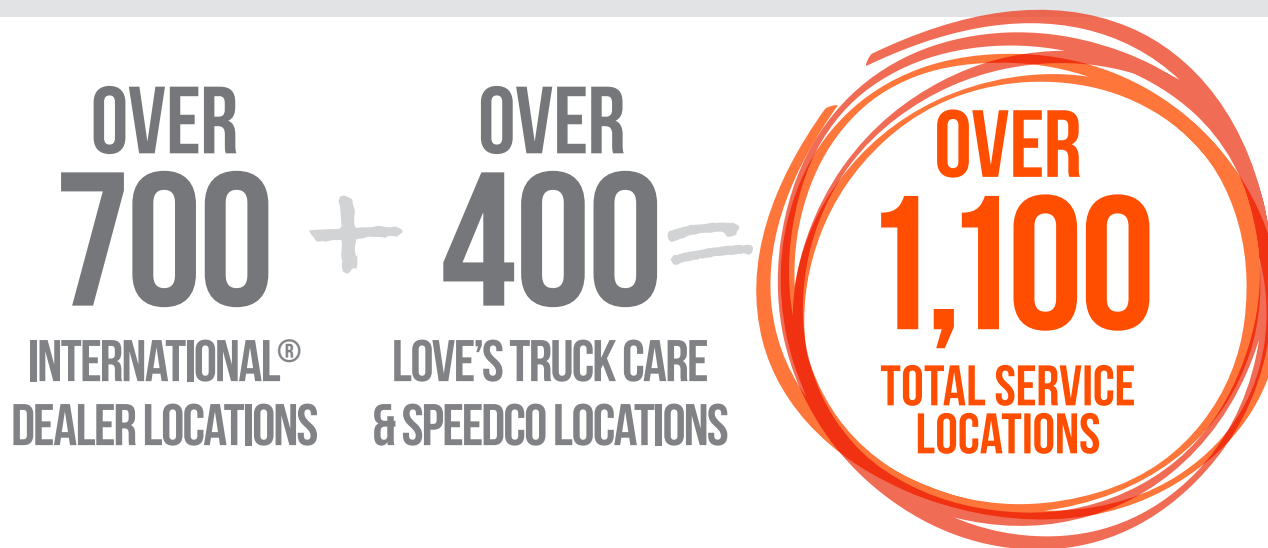

## TRUCK CARE

Our partnership with **Love's Truck Care & Speedco** adds 400+ additional locations for quick, conveniently located access to light mechanical and select warranty work\*.

# PARTS YOU NEED WHERE AND WHEN YOU NEED THEM

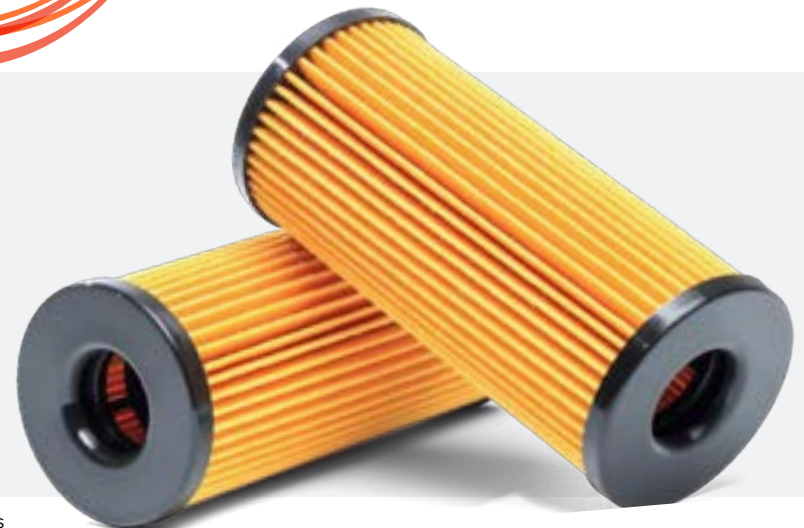

\* Warranty-covered parts must be a certified International installed part for International Truck dealer service locations to honor warranty. Love's and Speedco locations in Texas and Louisiana cannot perform warranty services.



# AVAILABLE CONFIGURATIONS



**Day Cab**

125" BBC  
Local, Regional, Bulk, and Specialized Applications



**56" Low Roof Sleeper**

125" BBC  
Regional Line Haul, Bulk, Flatbed, and Specialized Applications



**56" Hi-Rise Sleeper**

125" BBC  
Regional Line Haul and Owner-Operator



**73" Hi-Rise Sleeper**

125" BBC  
Long Haul Flatbed, Owner-Operator and Specialized Applications



**73" Sky-Rise Sleeper**

125" BBC  
Long Haul and Owner-Operator





# LT<sup>®</sup> SERIES SPECIFICATIONS

## BBC/BA

- ▶ 125" BBC / 50" BA

## Cab Configurations

- ▶ Day Cab
- ▶ 56" Low Roof Sleeper
- ▶ 56" Hi-Rise Sleeper
- ▶ 73" Hi-Rise Sleeper
- ▶ 73" Sky-Rise Sleeper

## Axle Configurations

- ▶ 4x2
- ▶ 6x2
- ▶ 6x4

## Frames

- ▶ Heat-Treated Alloy Steel 120,000 PSI

## Integrated Powertrains

- ▶ International<sup>®</sup> S13 12.74L
  - 400 - 515 hp
  - 1,450 - 1,850 lb.-ft.
- ▶ International<sup>®</sup> T14
  - 14-speed automated manual transmission

## Engines

- ▶ International<sup>®</sup> A26 12.4L
  - 400 - 515 hp
  - 1,450 - 1,850 lb.-ft.
- ▶ Cummins<sup>®</sup> X15 15L
  - 400 - 565 hp
  - 1,450 - 2,050 lb.-ft.

## Transmissions

- ▶ Automated Manual Transmissions
  - Eaton Endurant: 11, 12 speed
  - Eaton Fuller UltraShift PLUS: 13, 18 speed
  - Eaton Fuller Advantage: 10 speed
- ▶ Manual Transmissions
  - Eaton Fuller: 10 speed
  - Fuller: 10, 13, 18 speed

## Front Axles

- ▶ Hendrickson: 12,350 - 14,000 lbs.
- ▶ Meritor: 12,350 - 14,000 lbs.
- ▶ Dana Spicer: 12,350 - 14,000 lbs.

## Front Suspension

- ▶ Spring Monoleaf: 12,350 - 13,200 lbs.
- ▶ Parabolic Taperleaf: 12,350 - 14,000 lbs.

## Single Rear Axles

- ▶ Meritor: 23,000 lbs.
- ▶ Dana Spicer: 23,000 lbs.

## Tandem Rear Axles

- ▶ Meritor: 40,000 - 46,000 lbs.
- ▶ Dana Spicer: 40,000 - 46,000 lbs.

## Rear Suspensions

- ▶ AIR SINGLE
  - International<sup>®</sup>: 20,000 lbs.
- ▶ AIR TANDEM
  - International: 40,000 lbs.
  - Hendrickson: HAS 40,000 - 46,000 lbs.

## Brakes

- ▶ Air Drum Brakes with Automatic Traction Control and Electronic Stability Control
- ▶ Air Disc Brakes with Automatic Traction Control and Electronic Stability Control

## Interiors

- ▶ Three Trim Levels:
  - Classic, Diamond, Diamond Elite





# S13 INTEGRATED

Engine Type	Diesel, 4-Cycle
Configuration	Inline 6-Cylinder
Displacement	12.7L (777 cu. in.)
Bore & Stroke	4.96 in. & 6.54 in. (126 mm & 166 mm)
Compression Ratio	23:1
Aspiration	Fixed Geometry Turbocharger
Combustion System	1800 bar Common Rail
Engine Lubrication	42 Quarts (40L)
Total Engine Weight (Dry)	2,500 lbs. (1,134 kg)
Valves	4 Valves per Cylinder, Dual Overhead Camshaft
B10 Design Life	1,200,000 mi (1,931,000 km)



# T14 TRANSMISSION

Deep low-end gearing and shifting smoothness, delivering efficiencies of a direct drive in an overdrive package

14 speed with 2 crawler gears

A lightweight, efficiently packaged, and robustly designed gearbox with unlimited GCW

Single countershaft transmission designed for simplicity and reliability

### Transmission Base Warranty (includes towing)

Transmission	5 years; 750,000 miles (1,200,000 km)
Clutch	3 years; 350,000 miles (563,000 km)

### Gear Ratios

Gear	Ratio	% Step
R2	12.60	
R1	16.23	
1	20.81	29%
2	16.16	29%
3	12.57	29%
4	9.76	29%
5	7.56	29%
6	5.87	29%
7	4.55	29%
8	3.53	28%
9	2.77	29%
10	2.15	29%
11	1.66	29%
12	1.29	29%
13	1.00	28%
14	0.78	-

# Lightweight, Quiet and Efficient Power

## INTERNATIONAL® A26

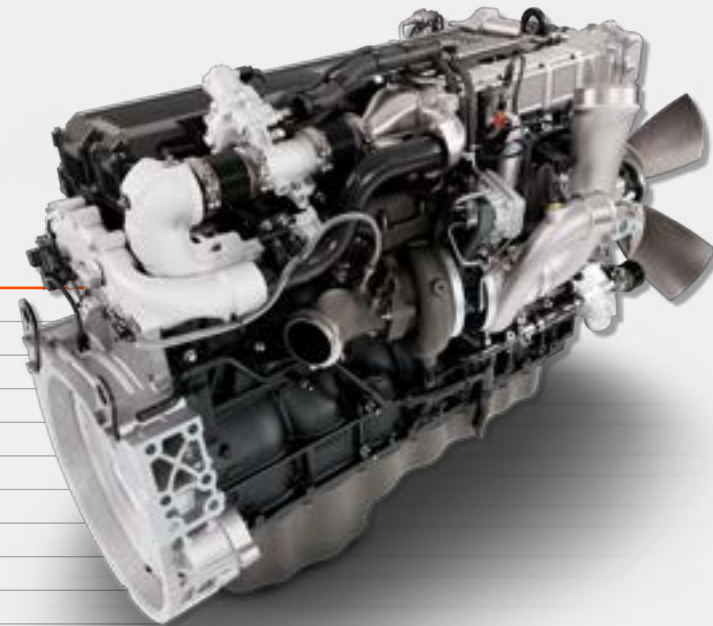

Engine Type	Diesel, 4-Cycle
Configuration	Inline 6-Cylinder
Displacement	12.4L (758 cu. in.)
Bore & Stroke	4.96 in. & 6.54 in. (126 mm & 166 mm)
Compression Ratio	20.5:1
Aspiration	Variable Geometry Turbocharger
Combustion System	Direct Injection 2500 bar HPCR
Engine Lubrication	42 Quarts (40L)
Total Engine Weight (Dry)	2,314 lbs. (1,050 kg)
Valves	4 Valves per Cylinder, Dual Overhead Camshaft
B10 Design Life	1,200,000 mi (1,931,000 km)



## CUMMINS® X15

Engine Type	Diesel, 4-Cycle
Configuration	Inline 6-Cylinder
Displacement	14.9L (912 cu. in.)
Bore & Stroke	5.39 in. & 6.65 in. (137 mm & 169 mm)
Compression Ratio	18.9:1
Aspiration	Variable Geometry Turbocharger
Combustion System	Direct Injection XPI Fuel System
Engine Lubrication	56 Quarts (53L)
Total Engine Weight (Dry)	2,961 lbs. (1,343 kg)
Valves	4 Valves per Cylinder, Single Overhead Camshaft
B10 Design Life	1,000,000 mi (1,609,000 km)

# Proven Muscle for the Long Haul



**Note:** The information and conclusions contained herein are believed to be correct at time of publication, but do not necessarily apply to similar vehicles with different specifications or with production dates after the production of this publication. Vehicles with different specifications or later dates of production may yield different results. Vehicle specifications are subject to change without notice. TAD16013 11/2023 ©2023 NAVISTAR Inc. All rights reserved. All marks are trademarks of their respective owners.